

## Introduction - Knobsets

UNION knobsets are ideal for use on timber doors. The outside rose and backplate are adjustable to allow for various door thicknesses, between 33mm and 51mm. UNION knobsets can be fitted with a 60mm or 70mm backset.

## Features and Functions

The following diagram gives an overview of the main features and functions of UNION knobsets. For a full explanation of terminology, please refer to the glossary on page 0.10 in the introduction at the front of the catalogue.

### Deadlocking Latch

When the door is closed a pin in the latch is automatically depressed which deadlocks the latch preventing it from being forced back

### Removable Cylinder

The knobset cylinder can be removed to allow for a cost effective key change in the event of lost keys

### Handing

All knobsets feature a solid brass reversible latch to suit either hand of door

### Room Occupied Indicator

The 'Hotel' set features an indicator in the outside knob which shows when the room is occupied

### Anti-Lockout

Push button knobs have an anti-lockout function which means that if the door is shut with the inside button depressed, it is automatically released to prevent a lockout

### Backset Size

Knobset backset is 60mm or 70mm.

### Variations

Combinations of the inside and outside knobs create sets with different functions

- Non-locking**  
Rotating the knob will always retract the latch
- Key Locking**  
A turn of the key locks or unlocks the knob
- Push Button**  
Operation of the push button locks the outside knob
- Turn Button**  
Turning of the button locks or releases the outside knob
- Emergency Button**  
Turning the slotted emergency release button unlocks the knob

### Keys

All key locking knobs are supplied with 3 keys

5C Knobsets

## Key Control Systems

UNION lever knobsets can be supplied individually keyed, keyed alike, key to pass or masterkeyed depending upon suite complexity. Please check with your local UDC office or UK Export Administrator for further information.

## Finishes

UNION knobsets are available in Antique Brass (AB), Antique Bronze (AZ), Polished Brass (PB), Chrome Plated (CP) and Satin Stainless Steel (SS).

## Guarantee

UNION knobsets are supplied with a 1 year guarantee.

## Classic Range

## U96900

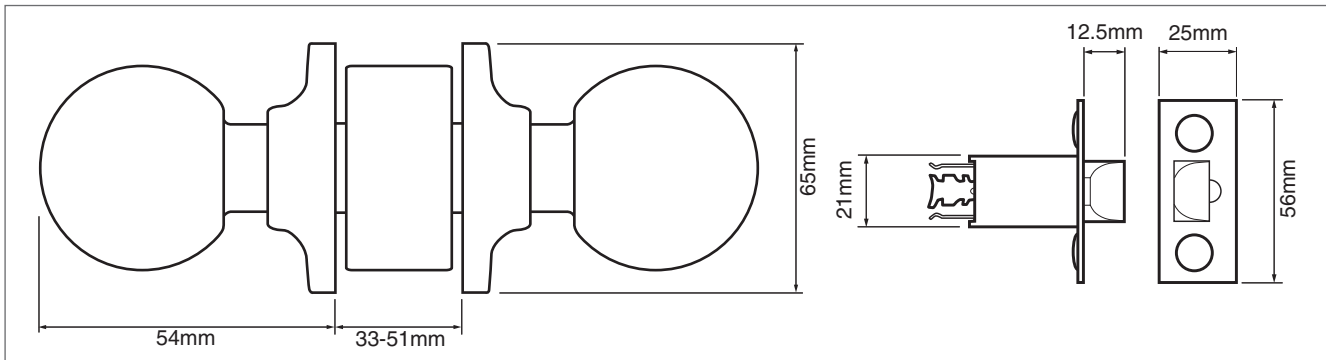

Entrance Set  
U96900

Inside



Turn locks outside knob

Outside



Key locks and unlocks both knobs

Classroom Set  
U96901

Inside



Outside



Key locks outside knob

Night Latch Set  
U96902

Inside

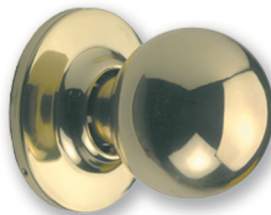

Outside



Key operates latch (fixed knob)

Bathroom Set  
U96903

Inside



Push button locks outside knob

Outside



Emergency release of both knobs

## Classic Range

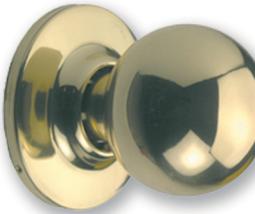
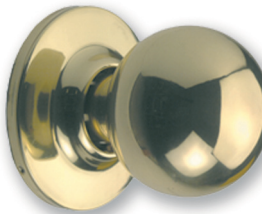

## U96900

Patio Set U96904	Inside		Outside	
	Push button locks outside knob			

Passage Set U96905	Inside		Outside	

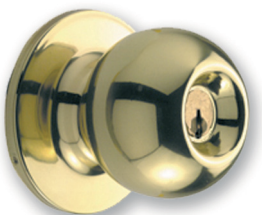
Hotel Set U96906	Inside		Outside	
	Push button disables outside key & knob			Key operates the latch

Stores Set U96907	Inside		Outside	
	Key operates latch (fixed knob)			Key operates latch (fixed knob)

Office Set U96910	Inside		Outside	
	Push button locks outside knob			Key unlocks both knobs

5C Knobsets



## Tulip Range

## U96500

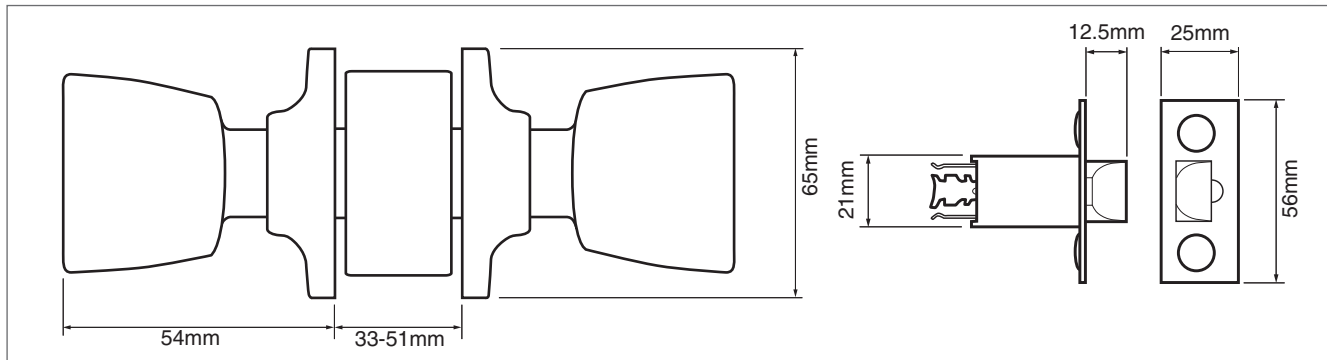

Entrance Set  
U96500

Inside



Turn locks outside knob

Outside



Key locks and unlocks both knobs

Classroom Set  
U96501

Inside

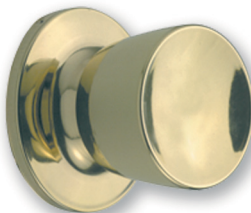

Outside



Key locks outside knob

Night Latch Set  
U96502

Inside

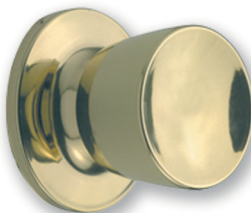

Outside



Key operates latch (fixed knob)

Bathroom Set  
U96503

Inside



Push button locks outside knob

Outside



Emergency release of both knobs



## Tulip Range

## U96500

Patio Set  
U96504

Inside

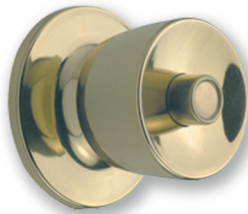

Outside

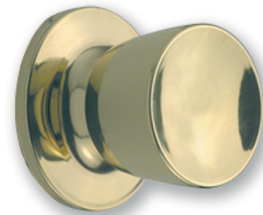

Push button locks outside knob

Passage Set  
U96505

Inside

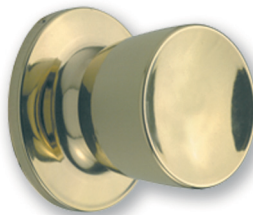

Outside

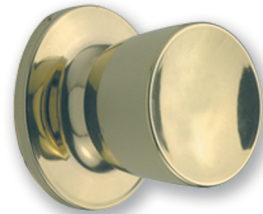

Hotel Set  
U96506

Inside



Outside



Push button disables outside key & knob

Key operates the latch

Stores Set  
U96507

Inside

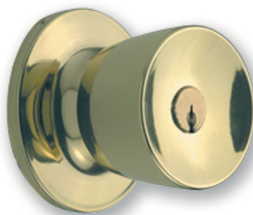

Outside



Key operates latch (fixed knob)

Key operates latch (fixed knob)

Office Set  
U96510

Inside



Outside



Push button locks outside knob

Key unlocks both knobs

# Knobsets

## Classic Range - Heavy Duty

## X96200 Series

### Application:

- Heavy duty knobset for timber doors hinged on the left or the right
- Suitable for heavy duty residential or medium duty commercial applications
- Suitable for doors from 35mm to 50mm thick

### Operation:

- See details

### Specification:

Reference	X96200 Series
Backset	60mm as standard 70mm available upon request
Cylinder Type	Solid Brass 6 pin
Keys	Supplied with 3 nickel plated brass keys
Latch Bolt	Deadlocking latch
Latch Bolt Projection	13mm

### Standards:



- ANSI Grade 2
- Exceeds 400,000 cycles



### Finishes:

- AB - Antique Brass
- AZ - Antique Bronze
- PB - Polished Brass finish
- CP - Chrome Plated
- SS - Satin Stainless Steel

### Ordering Code Example:

J - X96200 - SS  
(Boxed - Product Code - Finish)

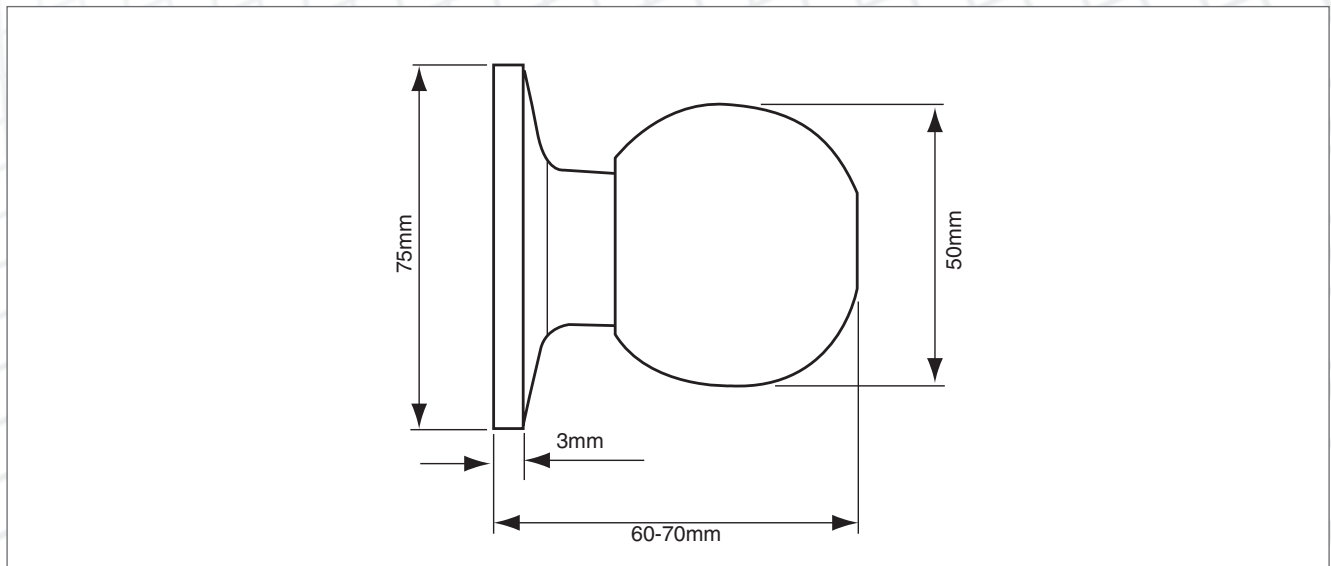

## Tulip Range - Heavy Duty

## X96250 Series

### Application:

- Heavy duty knobset for timber doors hinged on the left or the right
- Suitable for heavy duty residential or medium duty commercial applications
- Suitable for doors from 35mm to 50mm thick

### Operation:

- See details

### Specification:

Reference	X96250 Series
Backset	60mm as standard 70mm available upon request
Cylinder Type	Solid Brass 6 pin
Keys	Supplied with 3 nickel plated brass keys
Latch Bolt	Deadlocking latch
Latch Bolt Projection	13mm

### Standards:



- ANSI Grade 2
- Exceeds 400,000 cycles



### Finishes:

- AB - Antique Brass
- AZ - Antique Bronze
- PB - Polished Brass finish
- CP - Chrome Plated
- SS - Satin Stainless Steel

### Ordering Code Example:

J - X96250 - SS  
(Boxed - Product Code - Finish)

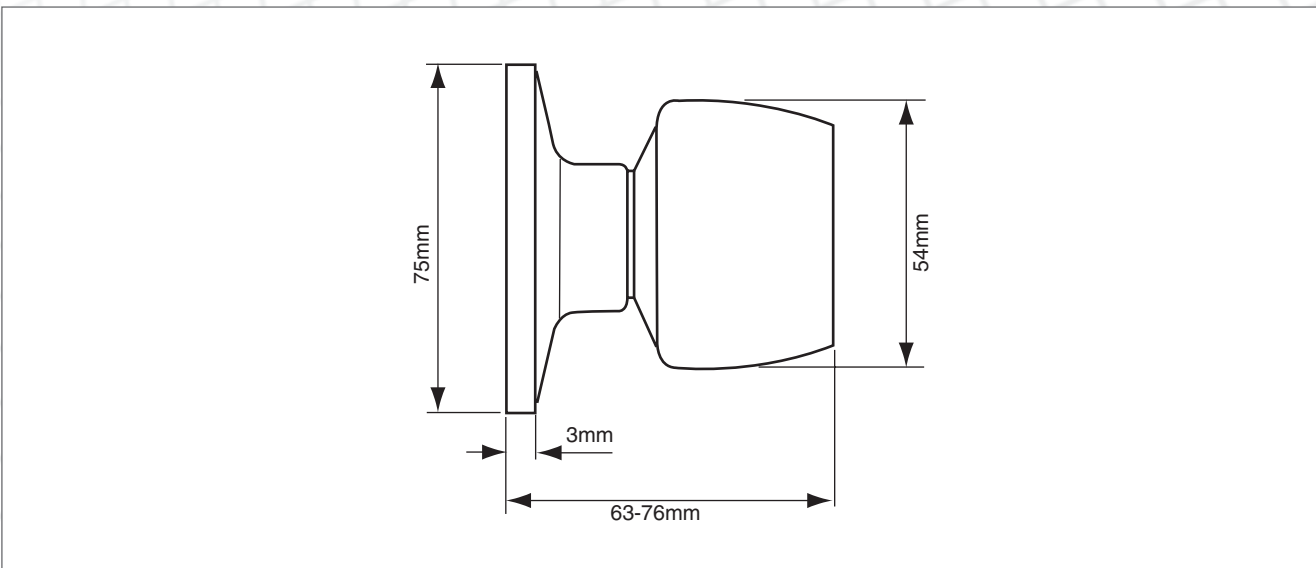



# Knobsets

## Functions - Classic & Tulip

# X96200 & X96250

### Entrance Lock

X96200 Classic  
X96250 Tulip

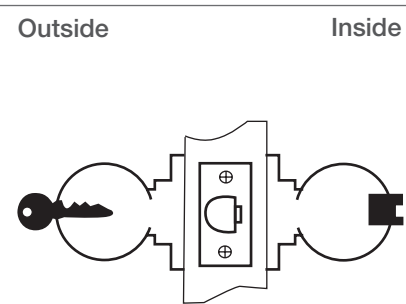

- For entrance doors
- Deadlocking latch bolt
- Either knob operates latch bolt (except when outside knob is locked from inside)
- Pushing button in on inside knob locks the outside one
- Turning inside knob or turning key in outside knob releases locked outside knob
- Outside knob may be retained in locked position by pushing and turning button clockwise to a horizontal position: not released until button is manually returned to the vertical position
- Latch bolt is operated by key in outside knob or by rotating inside knob
- Inside knob always active

### Dummy Trim

X9620 Classic  
X9625 Tulip

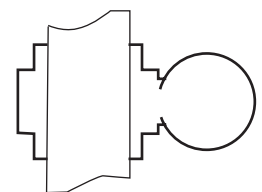

- For non-operational knob for decorative trim

### Classroom Lock

X96201 Classic  
X96251 Tulip

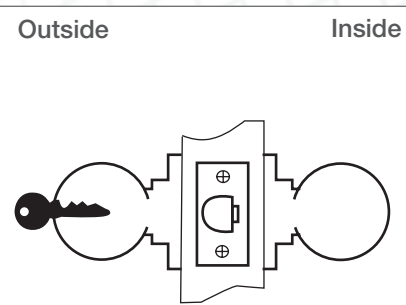

- For classroom or utility room doors
- Deadlocking latch bolt
- Either knob operates latch bolt (except when outside knob is locked by key)
- Inside knob always active
- Key releases outside knob

### Exit Latch

X96209 Classic  
X96259 Tulip

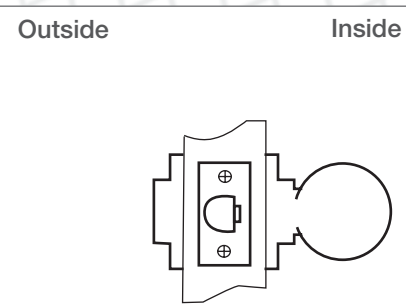

- For twin communicating or exit doors where one-side operation is required
- Also when space is limited between door and switch panel
- Deadlocking latch bolt
- One knob operation
- Blank rose
- Should be used only where rooms have more than one entrance

## Functions - Classic & Tulip

# X96200 & X96250

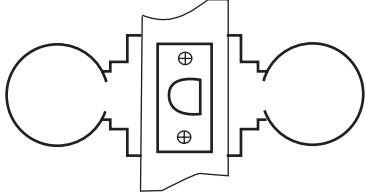
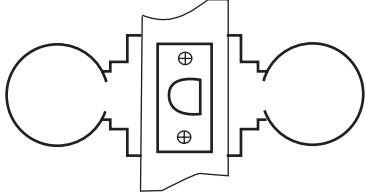
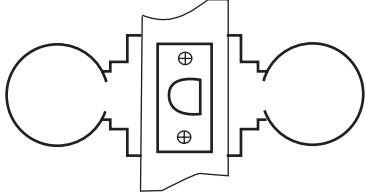
<p><b>Passage or Closet Latch</b></p> <p>X96205 Classic X96255 Tulip</p>	<table border="0"> <tr> <td style="text-align: center;">Outside</td> <td style="text-align: center;">Inside</td> <td></td> </tr> <tr> <td colspan="2" style="text-align: center;">  </td> <td> <ul style="list-style-type: none"> <li>• For doors that do not require locking</li> <li>• Either knob operates latch at all times</li> </ul> </td> </tr> </table>	Outside	Inside				<ul style="list-style-type: none"> <li>• For doors that do not require locking</li> <li>• Either knob operates latch at all times</li> </ul>
Outside	Inside						
		<ul style="list-style-type: none"> <li>• For doors that do not require locking</li> <li>• Either knob operates latch at all times</li> </ul>					

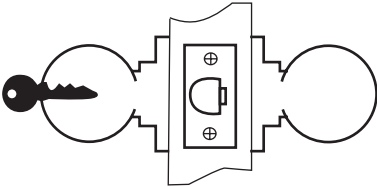
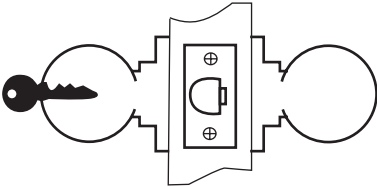
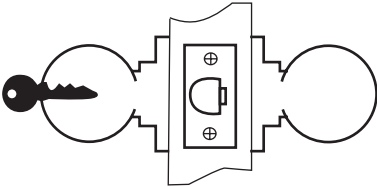
<p><b>Storeroom or Closet Lock</b></p> <p>X96207 Classic X96257 Tulip</p>	<table border="0"> <tr> <td style="text-align: center;">Outside</td> <td style="text-align: center;">Inside</td> <td></td> </tr> <tr> <td colspan="2" style="text-align: center;">  </td> <td> <ul style="list-style-type: none"> <li>• For use on storeroom, utility and exit doors</li> <li>• Deadlocking latch bolt</li> <li>• Latch bolt operated by knob inside, key in outside knob</li> <li>• Outside knob always rigid</li> <li>• Inside knob always active</li> </ul> </td> </tr> </table>	Outside	Inside				<ul style="list-style-type: none"> <li>• For use on storeroom, utility and exit doors</li> <li>• Deadlocking latch bolt</li> <li>• Latch bolt operated by knob inside, key in outside knob</li> <li>• Outside knob always rigid</li> <li>• Inside knob always active</li> </ul>
Outside	Inside						
		<ul style="list-style-type: none"> <li>• For use on storeroom, utility and exit doors</li> <li>• Deadlocking latch bolt</li> <li>• Latch bolt operated by knob inside, key in outside knob</li> <li>• Outside knob always rigid</li> <li>• Inside knob always active</li> </ul>					

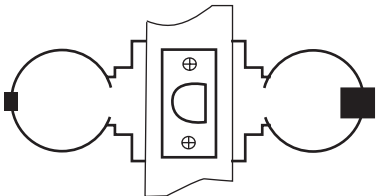
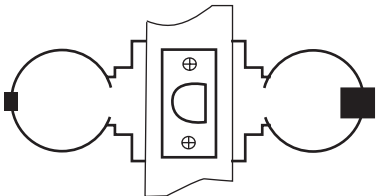
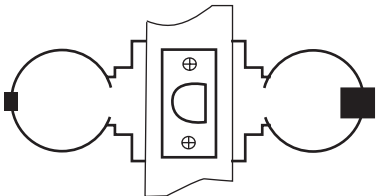
<p><b>Privacy, Bedroom or Bath Lock</b></p> <p>X96203 Classic X96253 Tulip</p>	<table border="0"> <tr> <td style="text-align: center;">Outside</td> <td style="text-align: center;">Inside</td> <td></td> </tr> <tr> <td colspan="2" style="text-align: center;">  </td> <td> <ul style="list-style-type: none"> <li>• For lavatory or other privacy doors</li> <li>• Either knob operates latch bolt unless outside knob is locked by push-button inside</li> <li>• Button automatically releases when inside knob is turned or door is closed</li> <li>• A coin inserted and turned in emergency slot will unlock door from outside</li> <li>• Inside knob always active</li> </ul> </td> </tr> </table>	Outside	Inside				<ul style="list-style-type: none"> <li>• For lavatory or other privacy doors</li> <li>• Either knob operates latch bolt unless outside knob is locked by push-button inside</li> <li>• Button automatically releases when inside knob is turned or door is closed</li> <li>• A coin inserted and turned in emergency slot will unlock door from outside</li> <li>• Inside knob always active</li> </ul>
Outside	Inside						
		<ul style="list-style-type: none"> <li>• For lavatory or other privacy doors</li> <li>• Either knob operates latch bolt unless outside knob is locked by push-button inside</li> <li>• Button automatically releases when inside knob is turned or door is closed</li> <li>• A coin inserted and turned in emergency slot will unlock door from outside</li> <li>• Inside knob always active</li> </ul>					

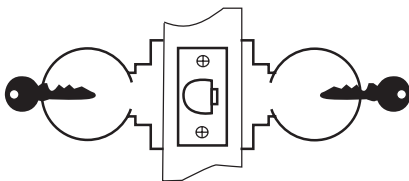
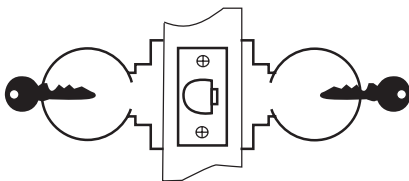
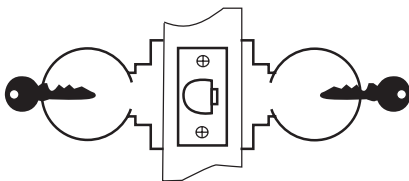
<p><b>Communicating Lock</b></p> <p>X96208 Classic X96258 Tulip</p>	<table border="0"> <tr> <td style="text-align: center;">Outside</td> <td style="text-align: center;">Inside</td> <td></td> </tr> <tr> <td colspan="2" style="text-align: center;">  </td> <td> <ul style="list-style-type: none"> <li>• For communicating or store entrance doors</li> <li>• Deadlocking latch bolt</li> <li>• Either knob operates latch bolt except when key in either knob locks the latch (key in either knob locks and unlocks independently of the other)</li> <li>• Should be used only for offices or rooms with multiple entries</li> </ul> </td> </tr> </table>	Outside	Inside				<ul style="list-style-type: none"> <li>• For communicating or store entrance doors</li> <li>• Deadlocking latch bolt</li> <li>• Either knob operates latch bolt except when key in either knob locks the latch (key in either knob locks and unlocks independently of the other)</li> <li>• Should be used only for offices or rooms with multiple entries</li> </ul>
Outside	Inside						
		<ul style="list-style-type: none"> <li>• For communicating or store entrance doors</li> <li>• Deadlocking latch bolt</li> <li>• Either knob operates latch bolt except when key in either knob locks the latch (key in either knob locks and unlocks independently of the other)</li> <li>• Should be used only for offices or rooms with multiple entries</li> </ul>					

# Knobsets

## Classic Range - Residential

## X96300 Series

### Application:

- A range of knobsets for timber doors hinged on the left or the right
- Suitable for residential and light commercial applications
- Suitable for doors from 35mm to 50mm thick

### Operation:

- See details

### Specification:

Reference	X96300 Series
Backset	60mm as standard 70mm available upon request
Cylinder Type	Solid Brass 5 pin
Keys	Supplied with 3 nickel plated brass keys
Latch Bolt	Deadlocking latch
Latch Bolt Projection	13mm

### Standards:



- ANSI Grade 3
- Exceeds 200,000 cycles



### Finishes:

- AB - Antique Brass
- AZ - Antique Bronze
- PB - Polished Brass finish
- CP - Chrome Plated
- SS - Satin Stainless Steel

### Ordering Code Example:

J - X96300 - SS  
(Boxed - Product Code - Finish)

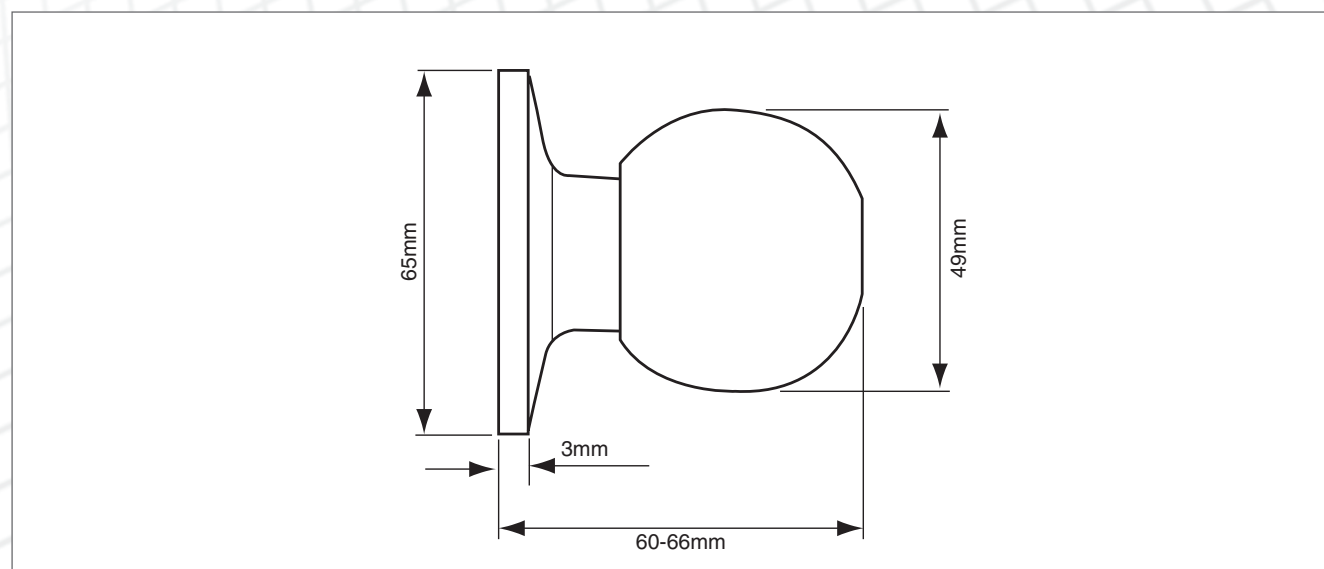



## Tulip Range - Residential

## X96350 series

### Application:

- A range of knobsets for timber doors hinged on the left or the right
- Suitable for residential and light commercial applications
- Suitable for doors from 35mm to 50mm thick

### Operation:

- See details

### Specification:

Reference	X96350 Series
Backset	60mm as standard 70mm available upon request
Cylinder Type	Solid Brass 5 pin
Keys	Supplied with 3 nickel plated brass keys
Latch Bolt	Deadlocking latch
Latch Bolt Projection	13mm

### Standards:



- ANSI Grade 3
- Exceeds 200,000 cycles

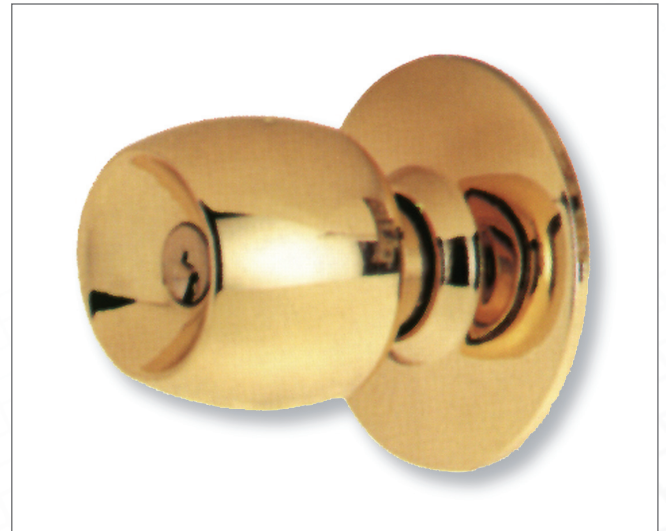

### Finishes:

- AB - Antique Brass
- AZ - Antique Bronze
- PB - Polished Brass finish
- CP - Chrome Plated
- SS - Satin Stainless Steel

### Ordering Code Example:

J - X96350 - SS  
(Boxed - Product Code - Finish)

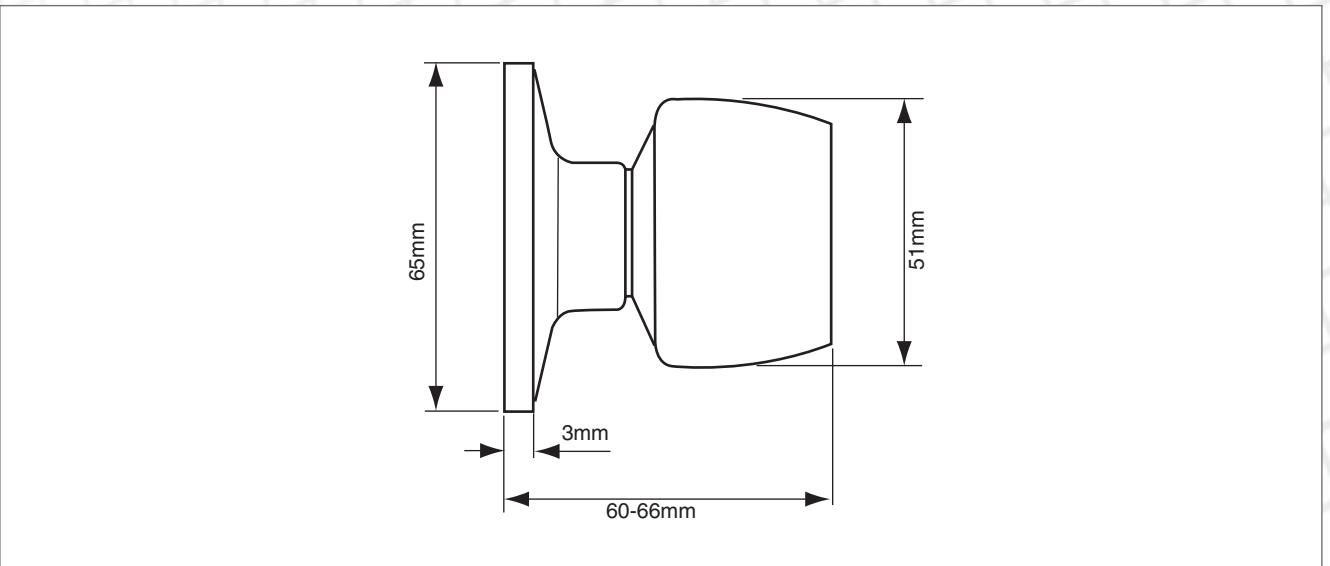

# Knobsets

## Functions - Classic & Tulip

# X96300 & X96350

5C Knobsets

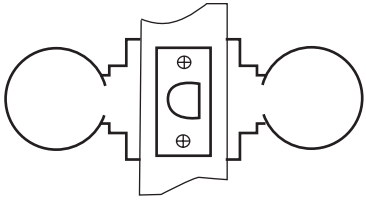
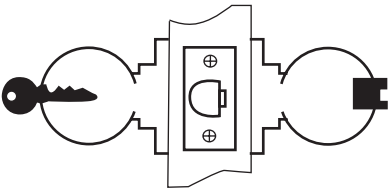
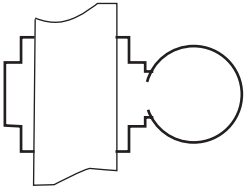
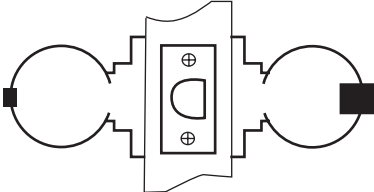
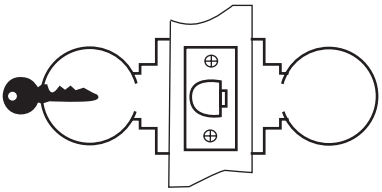
<p>Passage or Closet Latch</p> <p>X96305 Classic X96355 Tulip</p>	<div style="display: flex; justify-content: space-around;"> <span>Outside</span> <span>Inside</span> </div>  <ul style="list-style-type: none"> <li>• For doors that do not require locking</li> <li>• Either knob operates latch at all times</li> </ul>
<p>Entrance Lock</p> <p>X96300 Classic X96350 Tulip</p>	<div style="display: flex; justify-content: space-around;"> <span>Outside</span> <span>Inside</span> </div>  <ul style="list-style-type: none"> <li>• For entrance doors</li> <li>• Deadlocking latch bolt</li> <li>• Either knob operates latch bolt (except when outside knob is locked from inside)</li> <li>• Pushing button in on inside knob locks the outside one</li> <li>• Turning inside knob or turning key in outside knob releases locked outside knob</li> <li>• Outside knob may be retained in locked position by pushing and turning button clockwise to a horizontal position: not released until button is manually returned to the vertical position</li> </ul>
<p>Dummy Trim</p> <p>X9630 Classic X9635 Tulip</p>	 <ul style="list-style-type: none"> <li>• For non-operational knob for decorative trim</li> </ul>
<p>Privacy, Bedroom or Bath Lock</p> <p>X96303 Classic X96353 Tulip</p>	<div style="display: flex; justify-content: space-around;"> <span>Outside</span> <span>Inside</span> </div>  <ul style="list-style-type: none"> <li>• For lavatory or other privacy doors</li> <li>• Either knob operates latch bolt unless outside knob is locked by push-button inside</li> <li>• Button automatically releases when inside knob is turned or door is closed</li> <li>• A coin inserted and turned in emergency slot will unlock door from outside</li> <li>• Inside knob always active</li> </ul>
<p>Storeroom or Closet Lock</p> <p>X96307 Classic X96357 Tulip</p>	<div style="display: flex; justify-content: space-around;"> <span>Outside</span> <span>Inside</span> </div>  <ul style="list-style-type: none"> <li>• For use on storeroom, utility and exit doors</li> <li>• Deadlocking latch bolt</li> <li>• Latch bolt operated by knob inside, key in outside knob</li> <li>• Outside knob always rigid</li> <li>• Inside knob always active</li> </ul>